



CUSTOM FLATPACKS

Online **Cabinetry Ordering System** for Cabinet Makers

**LOCALLY
BASED IN
GIPPSLAND**



How H & F CUSTOM FLATPACKS works

in SIX EASY STEPS

STEP 1

Register to become a member

Sign up for **free** and get instant access at hfflatpacks.com.au



STEP 2

Open a new job and enter project details

Enter your job from the huge range of components and customise colours, dimensions and materials.

STEP 3

Generate quotes, instantly!

See pricing instantly. Easily quote jobs for your clients.



STEP 4

Submit projects with one click

Once your job is approved by you and your client, just hit 'submit' to get it manufactured.

STEP 5

Track jobs with real time project notifications

Track the progress of your job from your computer, tablet or mobile. Receive real time updates.

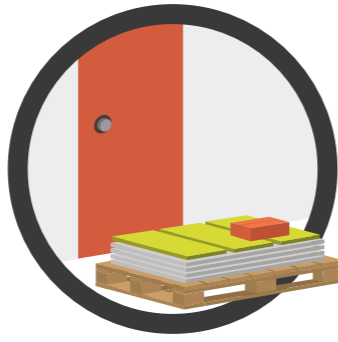

STEP 6

Delivered on-site, ready to install

H & F Custom Flatpacks gives you the flexibility to have your job delivered directly to the site, or for you to organise pick up.

No fees – EVER!

Send projects in 1 click

Support local business

Access top machinery

Instant quotes

All your jobs in 1 place

Flexibility to suit you

Help desk support

Customisable, quality cabinets manufactured using brands you **KNOW** and **TRUST**:

Door materials & finishes

Available in a range of door types including **Acrylic**, **Melamine**, **Polyurethane** & **Vinyl** OR **Non-Supply** options (cabinet carcass only).



Hardware



INDEX

BASE CABINETS 4-5

Applied Panels / Fillers	4
Open Base Units	4
Door Base Units	4
Drawer Base Units	5
Corner Base Units	5
Under Base Oven Units	5

UPPER CABINETS 6-7

Applied Panels / Fillers	6
Open Upper Units	6
Door Upper Units	6
Corner Upper Units	6
Aventos System Units	7
Rangehood Units	7

TALL CABINETS 8-11

Applied Panels / Fillers	8
Open Tall Units	8
Appliance Units	8
Door Tall Units	9
Corner Tall Units	9
Broom Units	9
Wall Oven Units	10
Fridge Units	10
Robe Units	10
Robe Drawer Units	11

PANTRY CABINETS 12-13

Applied Panels / Fillers	12
Door Pantry Units	12
Corner Pantry Units	13

BIN UNITS 14

COMPONENTRY 14



hfflatpacks.com.au



Begin your ordering from the ground up with our Base Cabinets.

APPLIED PANELS / FILLERS



Base Applied Panel



Base Filler

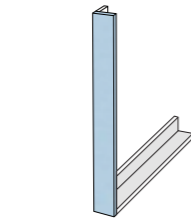

Base Filler Vermin Parts

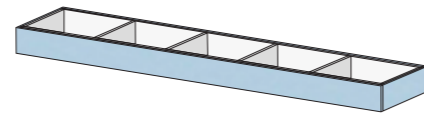

Kicker Framed

OPEN BASE UNITS

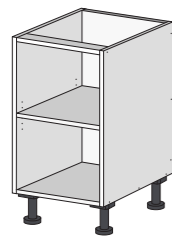

Open Base Carcase

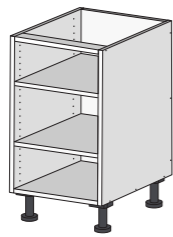

Carcase Base System 3 2

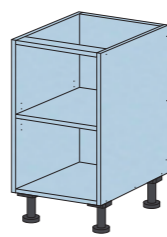

Open Base

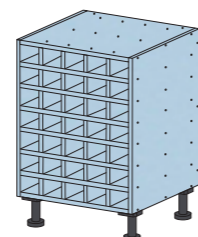

Base Winerack

DOOR BASE UNITS

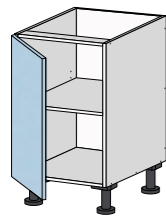

Base Door*

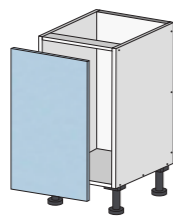

Base Pull Out

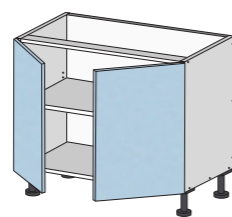

Base Pair of Doors

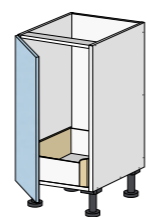

Base Standard Inner Drawer*

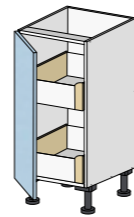

Base 2 Standard Inner Drawers*

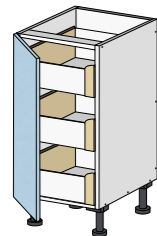

Base 3 Standard Inner Drawers*

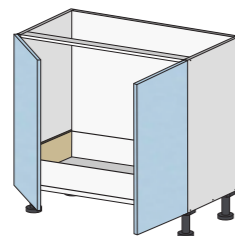

Base Pair 1 Standard Inner Drawer

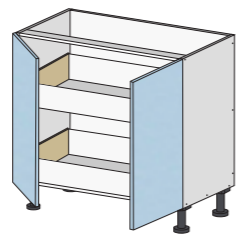

Base Pair 2 Standard Inner Drawers

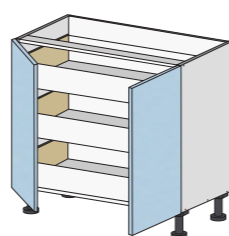

Base Pair 3 Standard Inner Drawers

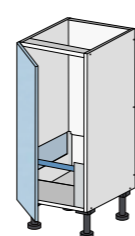

Base 1 Executive Inner Drawer*

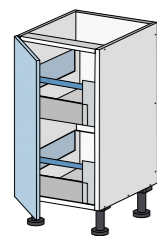

Base 2 Executive Inner Drawers*

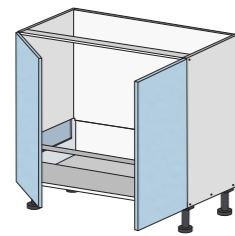

Base Pair 1 Executive Inner Drawer

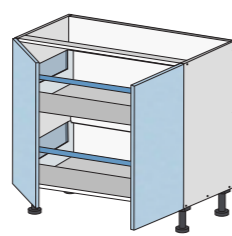

Base Pair 2 Executive Inner Drawers

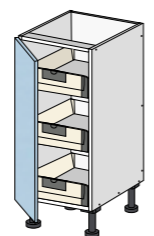

Base 3 Executive Inner Drawers*

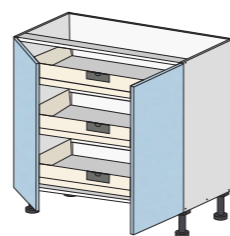

Base Pair 3 Executive Inner Drawers

*Available in left or right opening door configurations.

DRAWER BASE UNITS

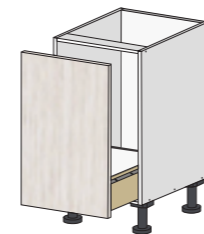

Base Drawers 1

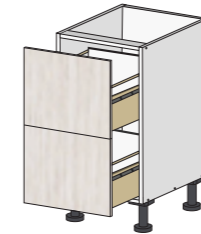

Base Drawers 2

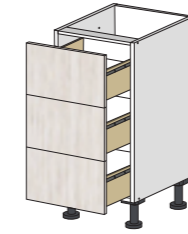

Base Drawers 3

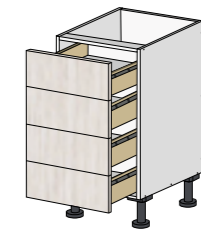

Base Drawers 4

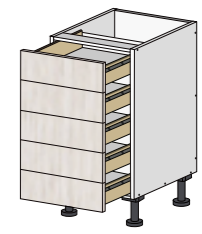

Base Drawers 5

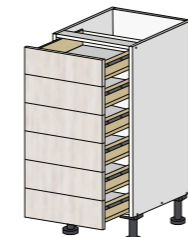

Base Drawers 6

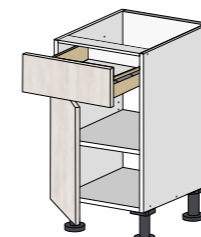

Base Door Drawer*

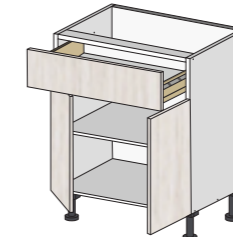

Base Pair Doors Drawer



VauthSagel Oil Tray Pull Out

CORNER BASE UNITS

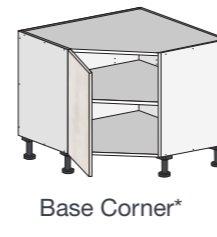

Base Corner*

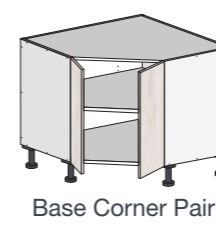

Base Corner Pair

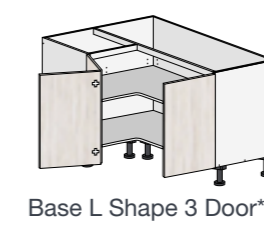

Base L Shape 3 Door*

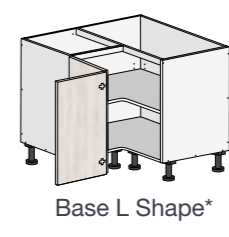

Base L Shape*



Base Ls 3 Drawers

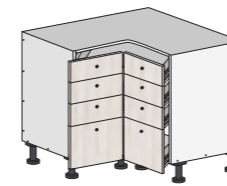

Base Ls 4 Drawer

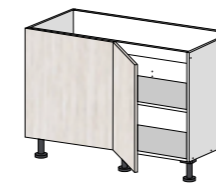

Base Return Door*



Base Return Pair Doors



Base Wari Corner*

UNDER BENCH OVEN UNITS

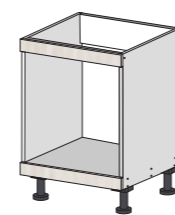

Base Oven

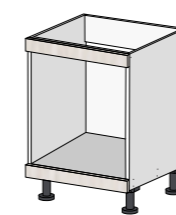

Base 600x600 Oven

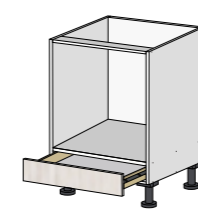

Base 600x600 Oven Drawer

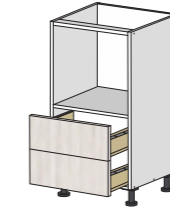

Base Oven 2 Drawer

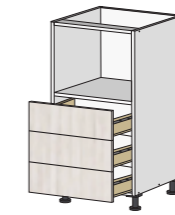

Base Oven 3 Drawer

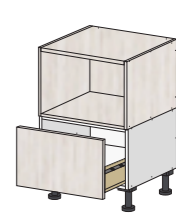

Base Microwave Drawer

*Available in left or right opening door configurations.



We offer a range of upper cabinets to ensure your client's storage needs are covered.

APPLIED PANELS / FILLERS

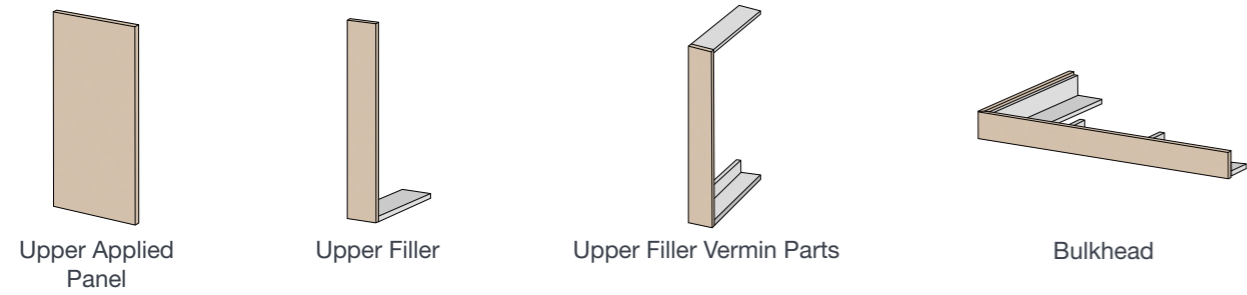

Upper Applied Panel Upper Filler Upper Filler Vermin Parts Bulkhead

OPEN UPPER UNITS

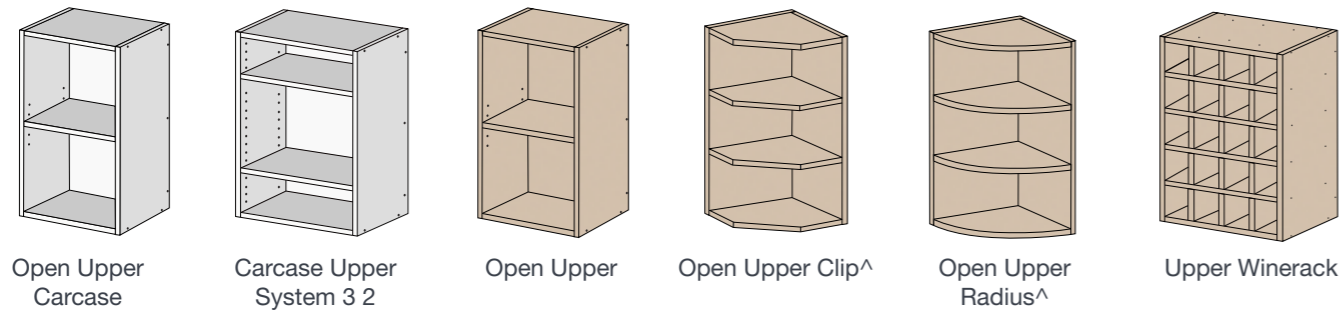

Open Upper Carcase Carcase Upper System 3 2 Open Upper Open Upper Clip^ Open Upper Radius^ Upper Winerack

DOOR UPPER UNITS

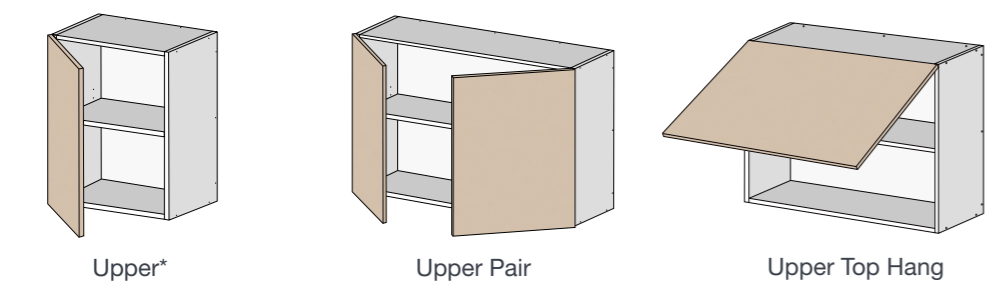

Upper* Upper Pair Upper Top Hang

CORNER UPPER UNITS

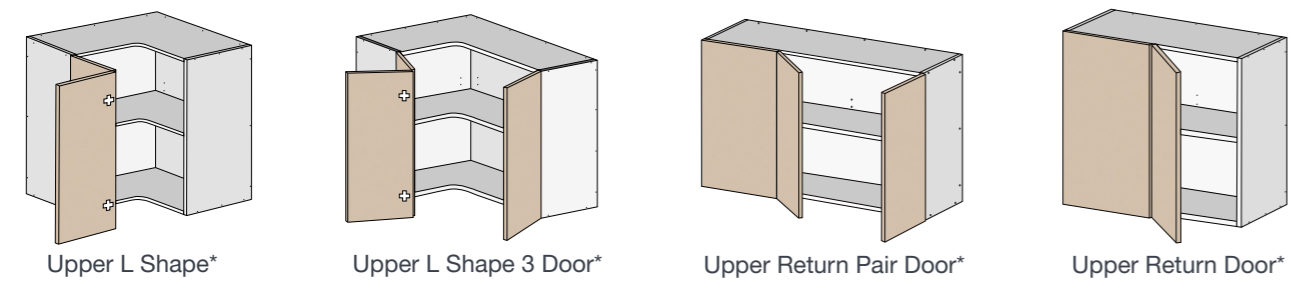

Upper L Shape* Upper L Shape 3 Door* Upper Return Pair Door* Upper Return Door*

AVENTOS SYSTEM UNITS

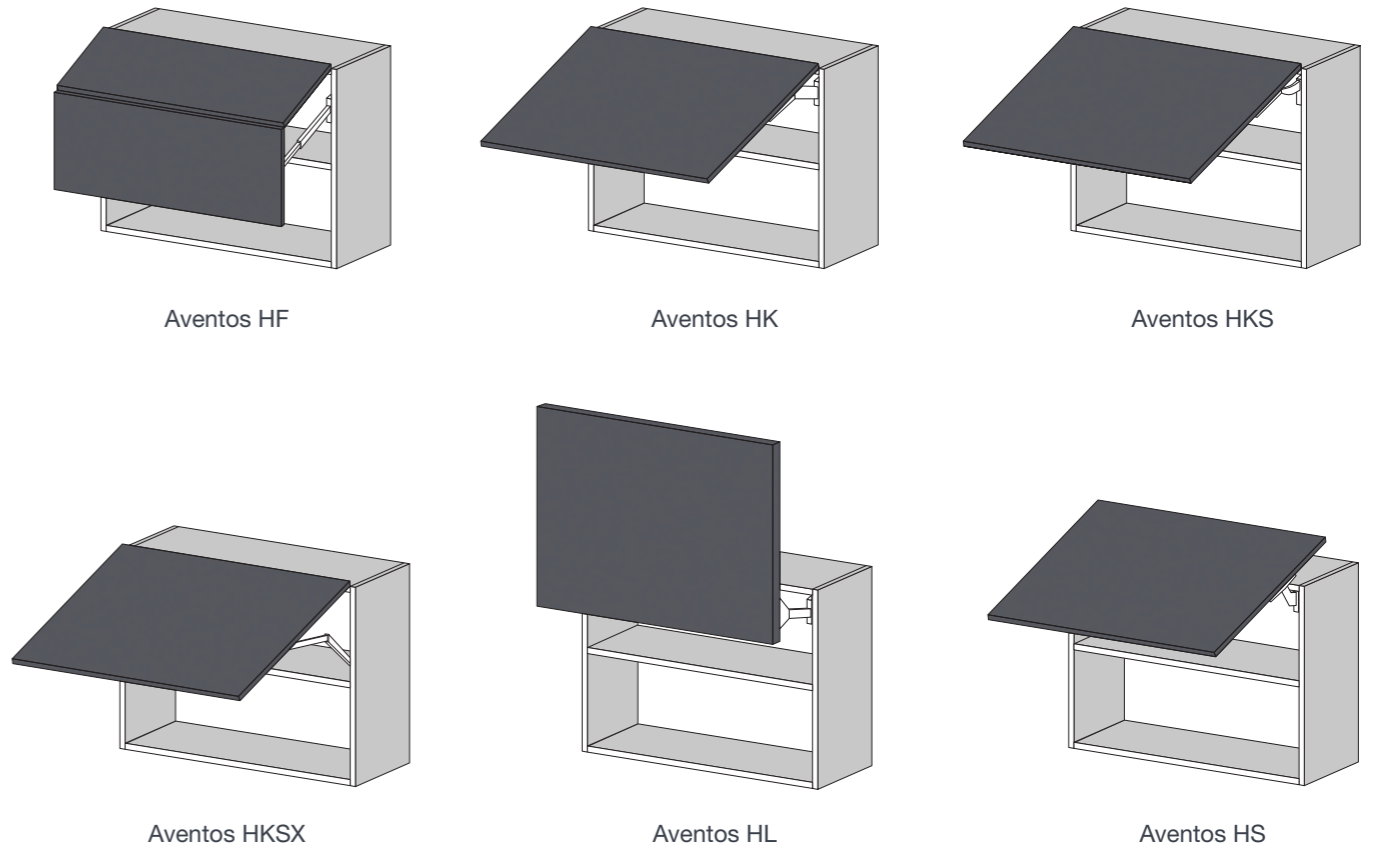

Aventos HF Aventos HK Aventos HKS Aventos HKSX Aventos HL Aventos HS

RANGEHOOD UNITS

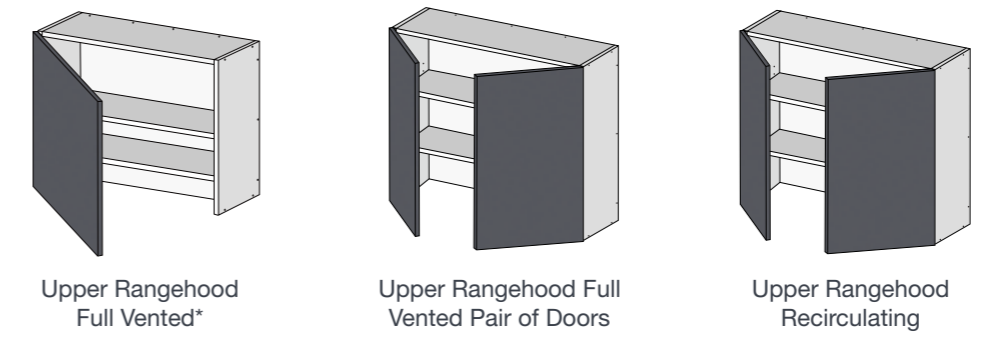

Upper Rangehood Full Vented* Upper Rangehood Full Vented Pair of Doors Upper Rangehood Recirculating

*Available in left or right opening door configurations.

^Available in left or right configurations.

*Available in left or right opening door configurations.



Increase the amount of storage within your client's home or office with our tall cabinets range.

APPLIED PANELS / FILLERS

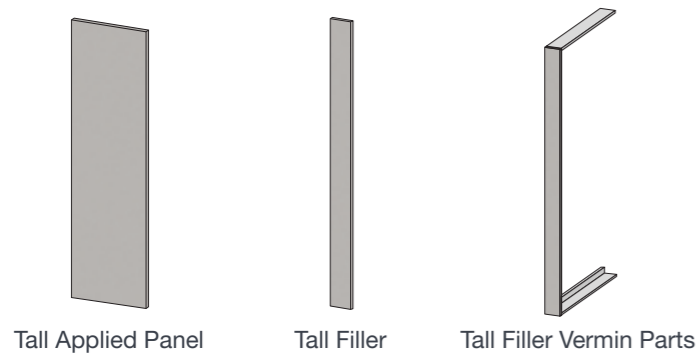

Tall Applied Panel Tall Filler Tall Filler Vermin Parts

OPEN TALL UNITS

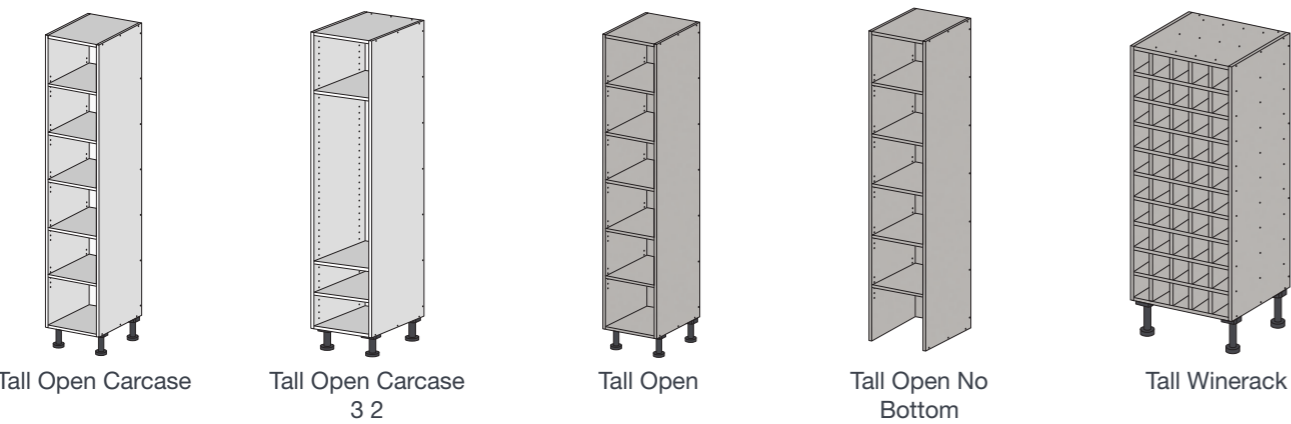

Tall Open Carcase Tall Open Carcase 3 2 Tall Open Tall Open No Bottom Tall Winerack

APPLIANCE UNITS

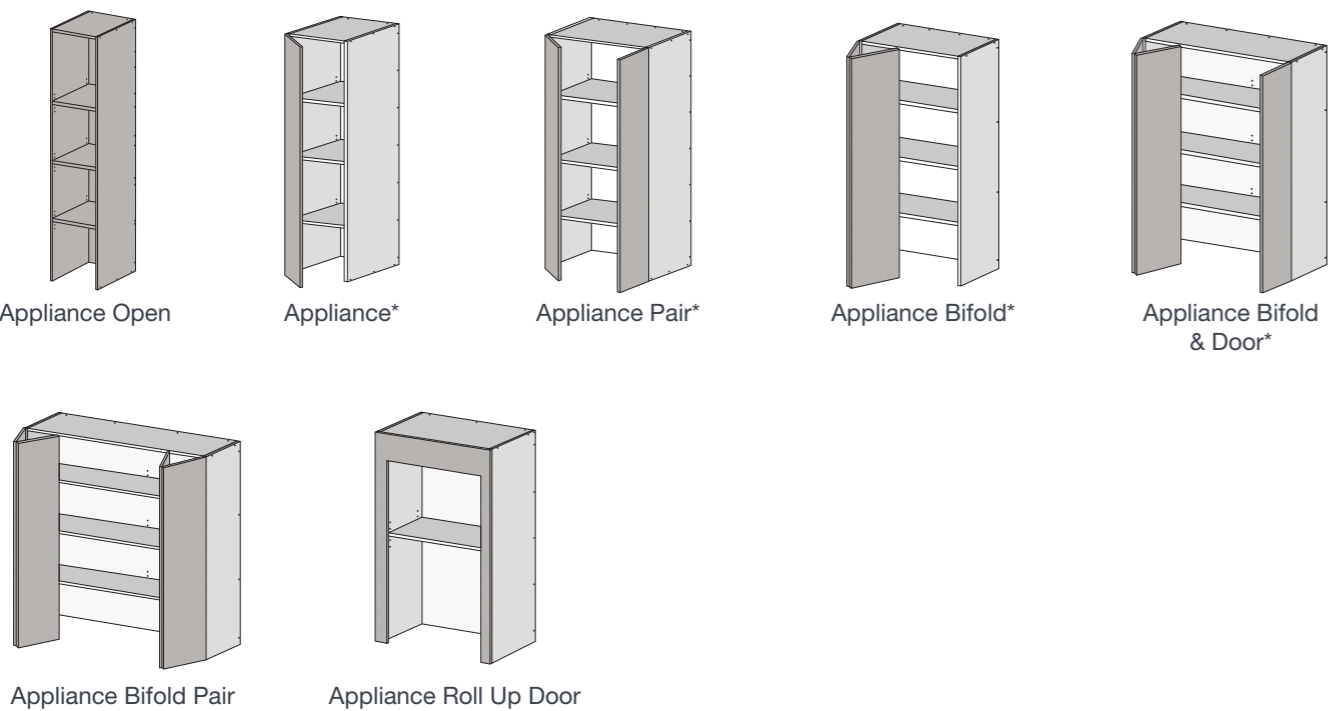

Appliance Open Appliance* Appliance Pair* Appliance Bifold* Appliance Bifold & Door* Appliance Bifold Pair Appliance Roll Up Door

DOOR TALL UNITS

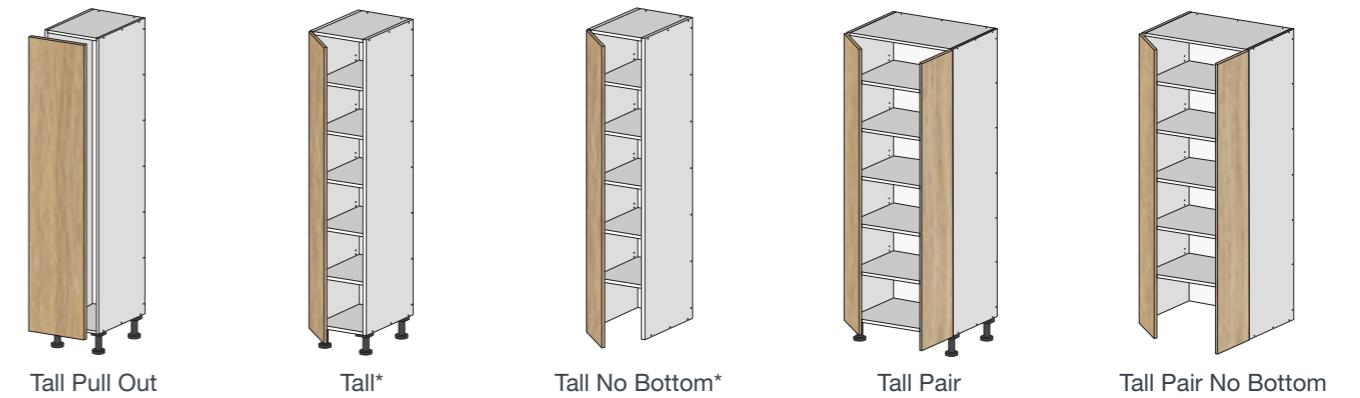

Tall Pull Out Tall* Tall No Bottom* Tall Pair Tall Pair No Bottom

CORNER TALL UNITS

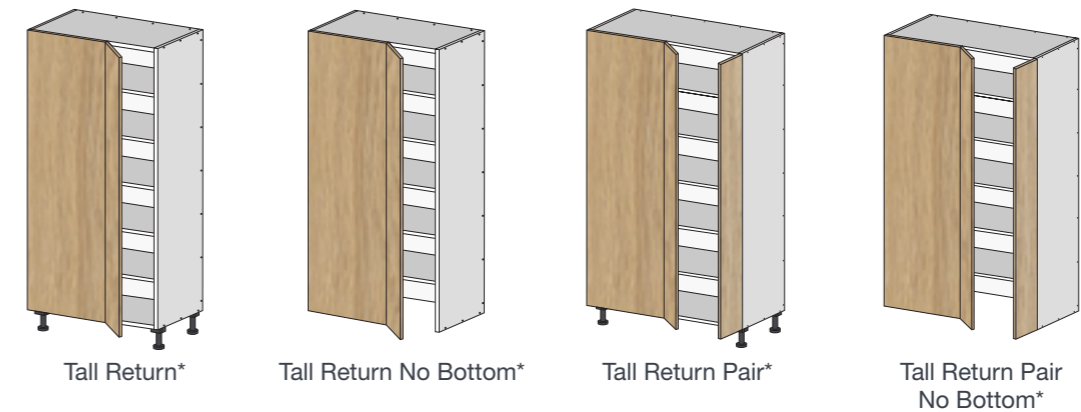

Tall Return* Tall Return No Bottom* Tall Return Pair* Tall Return Pair No Bottom*

BROOM UNITS

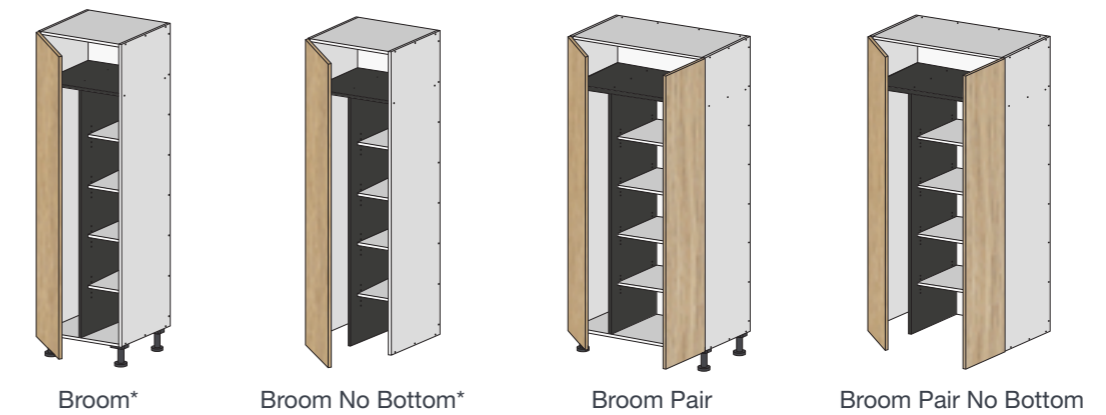

Broom* Broom No Bottom* Broom Pair Broom Pair No Bottom

*Available in left or right opening door configurations.

*Available in left or right opening door configurations.



WALL OVEN UNITS

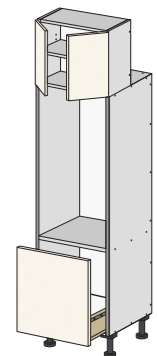

Wall Oven 1
Drawer

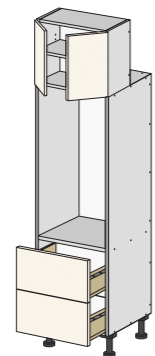

Wall Oven 2
Drawer

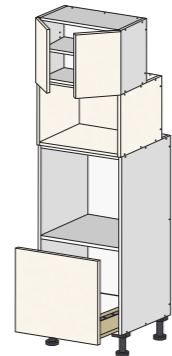

Wall Oven Micro
1 Drawer

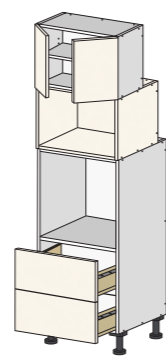

Wall Oven Micro
2 Drawer

FRIDGE UNITS

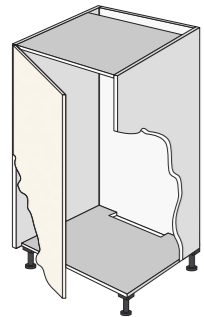

Generic Fridge*

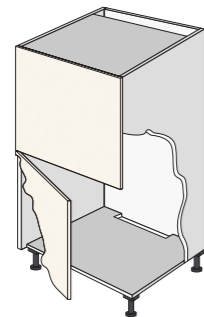

Generic Fridge Split Door*

ROBE UNITS

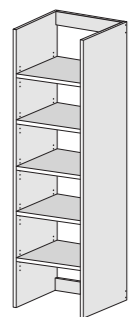

Robe Adjustable
Shelves

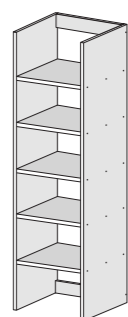

Robe Fixed Shelves

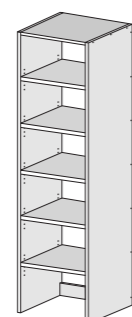

Robe Shelves
and Top

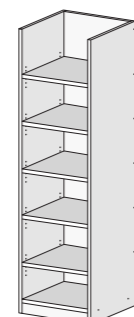

Robe Shelves Plus
Back and Bottom

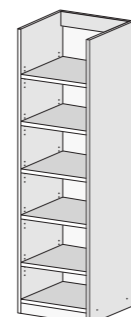

Robe Shelves
Plus Bottom



Robe Shelves Plus
Back, Top and Bottom

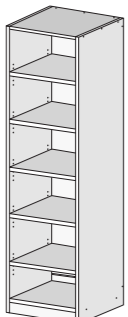

Robe Shelves Plus
Top and Bottom

ROBE DRAWER UNITS

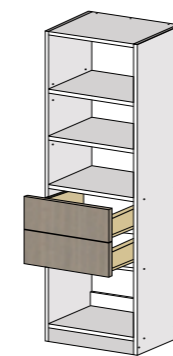

Robe 2 Drawers
and Shelves
and Top

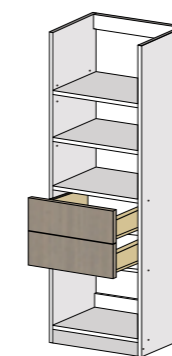

Robe 2 Drawers
and Shelves
and No Top

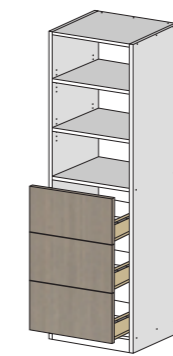

Robe 3 Drawers
and Shelves
and Top

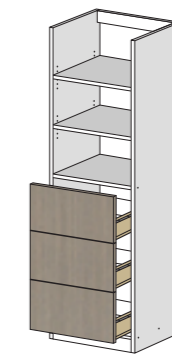

Robe 3 Drawers
and Shelves
No Top

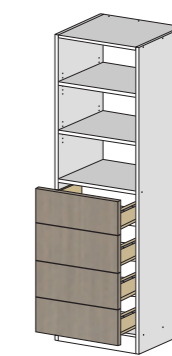

Robe 4 Drawers
and Shelves
and Top

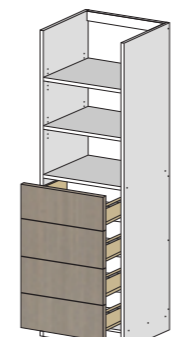

Robe 4 Drawers
and Shelves
No Top

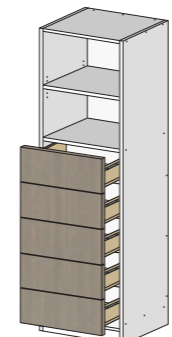

Robe 5 Drawers
and Shelves
and Top

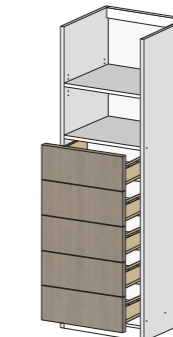

Robe 5 Drawers
and Shelves
No Top

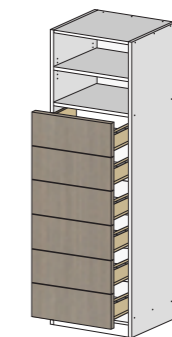

Robe 6 Drawers
and Shelves
and Top

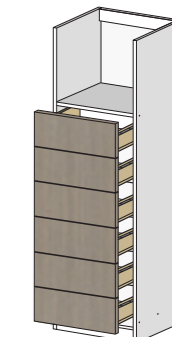

Robe 6 Drawers
and Shelves
No Top

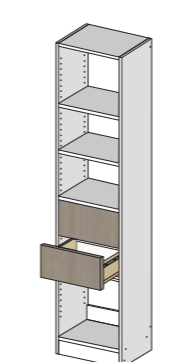

Robe 2 Inset
Drawers Back
Shelves and Top

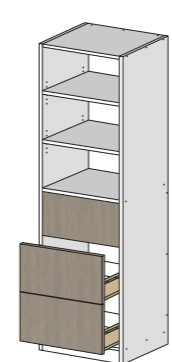

Robe 3 Inset
Drawers Back
Shelves and Top

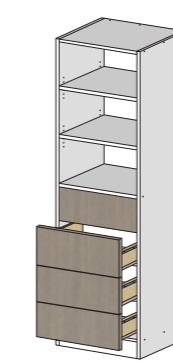

Robe 4 Inset
Drawers Back
Shelves and Top

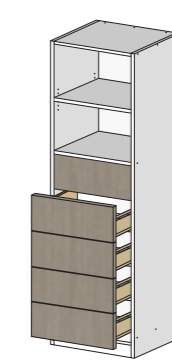

Robe 5 Inset
Drawers Back
Shelves and Top

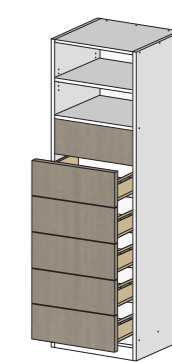

Robe 6 Inset
Drawers Back
Shelves and Top

We offer a range of Pantry Cabinets to suit any kitchen shape or size.

APPLIED PANELS / FILLERS

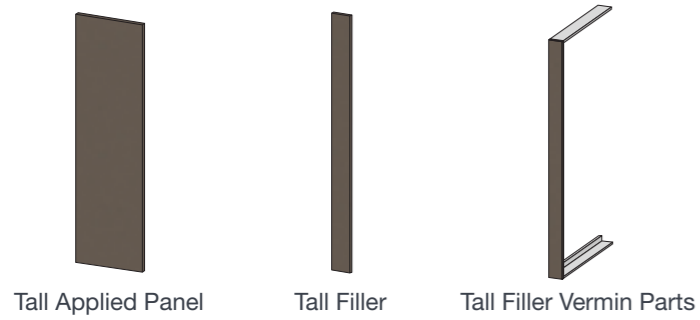

Tall Applied Panel

Tall Filler

Tall Filler Vermin Parts

DOOR PANTRY UNITS#



Pantry*

Pantry No Bottom*

Pantry Pair

Pantry Pair No Bottom

Pantry 2 Part

Pantry 2 Part Pair

Pantry 3 Standard Inner Drawers*

Pantry Left 4 Standard Inner Drawers*

Pantry Left 5 Standard Inner Drawers*

Pantry Pair 3 Standard Inner Drawers

Pantry Pair 4 Standard Inner Drawers

Pantry Pair 5 Standard Inner Drawers

Pantry 3 Executive Inner Drawers*

Pantry 4 Executive Inner Drawers*

Pantry 5 Executive Inner Drawers*

Pantry Pair 3 Executive Inner Drawers

Pantry Pair 4 Executive Inner Drawers

Pantry Pair 5 Executive Inner Drawers

Pantry 3 Premium Inner Drawers*

Pantry 4 Premium Inner Drawers*

Pantry 5 Premium Inner Drawers*

Pantry Pair 3 Premium Inner Drawers

Pantry Pair 4 Premium Inner Drawers

Pantry Pair 5 Premium Inner Drawers

*Available in left or right opening door configurations.

*Note: Black Shelves indicate the presence of a fixed shelf.

CORNER PANTRY UNITS#



Pantry Corner*

Pantry Corner No Bottom*

Pantry Corner Pair

Pantry Corner Pair No Bottom

Pantry Corner 2 Part*

Pantry Corner 2 Part No Bottom*

Pantry Corner 2 Part

Pantry Corner 2 Part No Bottom

Pantry Corner 3 Part*

Pantry Corner 3 Part No Bottom*

Pantry Corner 3 Part Pair

Pantry Corner 3 Part Pair No Bottom*

Pantry Return*

Pantry Return No Bottom*

Pantry Pair Return*

Pantry Pair Return No Bottom*

Pantry 2 Part Return*

Pantry 2 Part Return No Bottom*

Pantry 2 Part Return Pair

Pantry 2 Part Return Pair No Bottom*

*Available in left or right opening door configurations.

*Note: Black Shelves indicate the presence of a fixed shelf.

BIN UNITS

Tough pull-out bin systems in a variety of sizes, with or without utility drawer. Includes carcass.



Base Bin WBPB4560
with Inner Drawer



Base Bin WBPB4564



Base Bin WBPB5040
with Inner Drawer



Base Bin WBPB5064



Base Bin WBPB6060
with Inner Drawer



Base Bin WBPB6084

COMPONENTRY

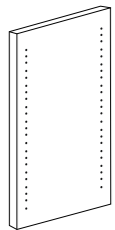

Panel Adjustable
Holes



Door

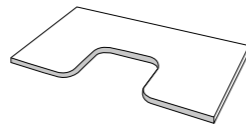

U Shape Shelf

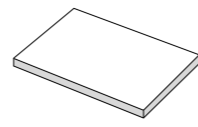

Manual Panel Interior

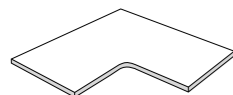

L shape panel

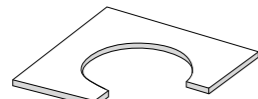

Key Shape Panel

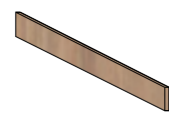

KickLength

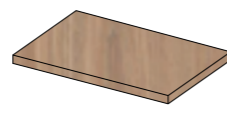

Manual Panel Exterior

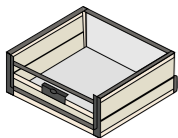

Inner Drawer Components



KickLength Brushed
Aluminium



KickLength Brushed
Stainless





CUSTOM
FLATPACKS

H & F Custom Flatpacks offers a **FREE** online ordering system that allows trade professionals to quote and order cabinets in real time, then send your orders directly to us in one click.

Projects are cut-to-size, ready to install and delivered on-site, or pick up from us in Leongatha.



Adrian Hall
0417 363 429

Callum Foat
0417 510 465

17 Cusack Road, Leongatha Vic 3953
info@hflatpacks.com.au



hflatpacks.com.au